

# **ENFORCER®**

## Room Occupancy Monitor Manual



### Features:

- Programmable to use PIR (movement), phototransistor (light), or door sensor input (switch) to detect occupancy
- 1-Room indicator has a programmable, built-in buzzer for service input
- Programmable reminder, 3~30 min
- Simple to install – micro USB or terminal block (5~12VDC)
- Suitable to use in restrooms, fitting rooms, etc. to monitor occupancy
- Indicators can be paired with up to 15 Sensors per channel
- Each sensor can transmit to unlimited number of indicators
- Service button connections available\*

\*RM-R100-TLQ and RM-R100-RB1Q only.

# ENFORCER Room Occupancy Monitor

## Introduction:

The ENFORCER Room Monitor can be used to monitor the occupancy status of rooms in high traffic areas: restrooms, fitting rooms, etc. The Room Monitor uses PIR and phototransistor sensors to monitor the occupancy of a room. The 1-Room Indicator includes additional features, such as a built-in buzzer and service button input, for applications where occupants may need assistance. The 2-Room Indicator is ideal for monitoring multiple rooms at once.

## What's Included in the Room Monitor Kit (RM-R100-KB1Q):

1x Sensor

1x 1-Room Indicator

2x USB Power cords

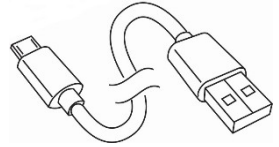

1x Indicator decal

1x Manual

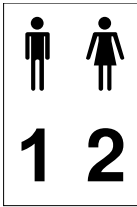

## Overview:

### Sensor\*

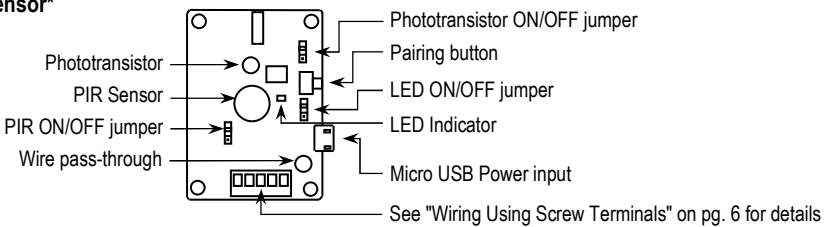

### Indicators\*

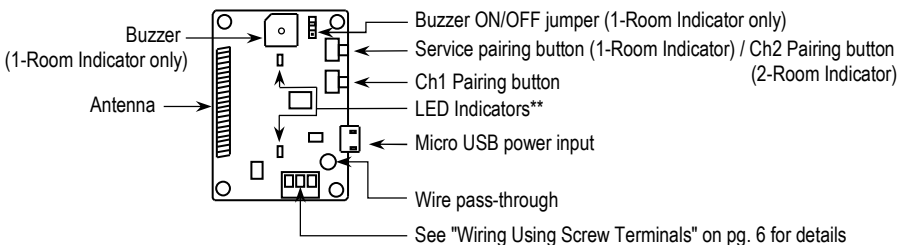

\*Jumpers are preset ON

\*\*2-Room Indicator has 4 LED indicators (2 for each channel).

## Installation Notes:

- Mount the Sensor and Indicator in locations where they are not exposed to weather or moisture, and where they are not surrounded by metal. Metal will block the RF signal, resulting in reduced range.
- For best results, mount the Sensor and Indicator with no more than one wall in between the two.
- If using USB power, make sure to replace the cover before connecting to the mini USB port.
- The door contact input should only be used for applications where the door being monitored is usually kept open.
- If an N.C. magnetic contact is being used to monitor the door then a 100k $\Omega$  resistor (not included) should be installed between the voltage and door contact inputs. See pg. 6, *Using a Magnetic Contact for Door Monitoring*, for more details.

## Basic DIY Installation Using Micro USB Power:

The Room Monitor Kit (RM-R100-KB1Q) is pre-learned and ready to go right out of the box. Just mount and connect to power via the included micro USB cable and any USB adapter. Follow the steps below for a basic installation.

1. Find a suitable location to mount the Sensor/ Indicator near a power source. Keep in mind that the included micro USB cord is 12" long.
2. Use a paper clip and program as needed. See *Setting a Reminder Time* and *Expanding the Room Monitor System* (pgs. 4~5).

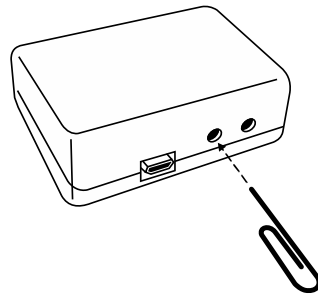
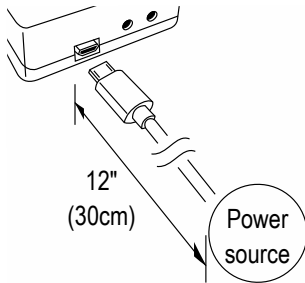

3. Apply double-sided mounting tape to the back of the Sensor/Indicator and mount.
4. Connect the micro USB plug to the Sensor/Indicator and connect to power.

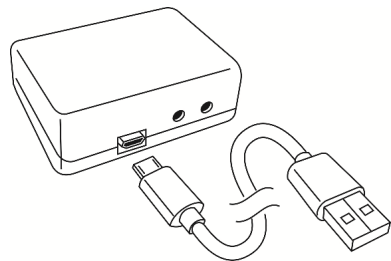
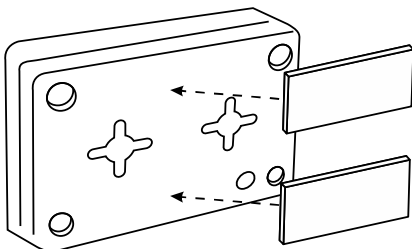

# ENFORCER Room Occupancy Monitor

## Setting a Reminder Time:

The Room Monitor Sensors and Indicators can be programmed to flash if the room has been occupied for an extended period of time.

1. Connect to power and press the pairing button within 5 seconds of powering on.
2. After pressing the pairing button, count number of times the LEDs flash
3. Press the pairing button until desired reminder time is set. See table below for reminder time settings.

# of Flashes	1	2	3	4	5	6	7
Reminder time	Disabled	3min	5min	10min	15min	20min	30min

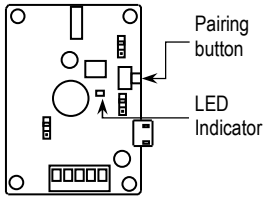

Sensor  
(RM-R100-TLQ)

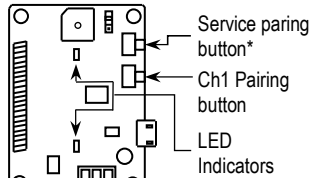

1-Room Indicator  
(RM-R100-RB1Q)

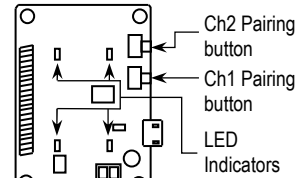

2-Room Indicator  
(RM-R100-R2Q)

\*Service pairing button cannot be used to set a reminder time.

## Clear Channel Memory:

To clear all codes from a channel's memory, press the channel's pairing button for 3 seconds or more until the channel indicator LED begins flashing. Release, and then press the button again for 3 seconds or more until the LED stops flashing. The LED will then flash twice to indicate that all codes associated with that channel have been deleted.

## Display Channel Memory:

To see how many codes have been learned by a channel, press that channel's pairing button once. The number of codes stored in the channel's memory corresponds with the number of times the channel's LED indicators flash.

## Expanding the Room Monitor System:

Each channel of an Indicator can learn the codes of up to 15 different Sensors or Indicator Remote buttons on a first-in, first-out basis. The procedure for pairing a new Sensor/button to an Indicator is as follows:

1. Once the Indicator has been powered on for over 5 seconds, press the pairing button of the desired channel for 3 seconds or more. The channel's LED will start to flash quickly to indicate that it is in learning mode.
2. While the LED is flashing, press the button on the Sensor/Remote to be learned one time. The channel's LED indicator will flash once to indicate the Sensor/button has been successfully paired. After the Sensor/button has been paired, the Indicator will automatically exit learning mode. Repeat the above to pair additional Sensors or Indicator Remote buttons.

### NOTES:

- The channel's LED indicator will flash a maximum of 30 seconds. If no device is paired during this time, the Indicator will automatically exit learning mode, and the LED will turn off.
- If the Sensor or Indicator Remote button being paired has already been paired before, the channel indicator LED will turn steady ON and then start flashing. The Sensor/button will not be paired twice.
- One channel can learn the codes of a maximum of 15 Sensors/buttons. If you attempt to learn a sixteenth code, the earliest code learned will be deleted and the new code will be learned.

## Expanded Sample Application

The Room Monitor can be used in a variety of situations to monitor room occupancy, or even assist customers if used with the Wall-Mount Help Button. After the Wall-Mount Help Button has been pressed, 1-Room Indicators can be reset remotely if paired with an Indicator Remote.

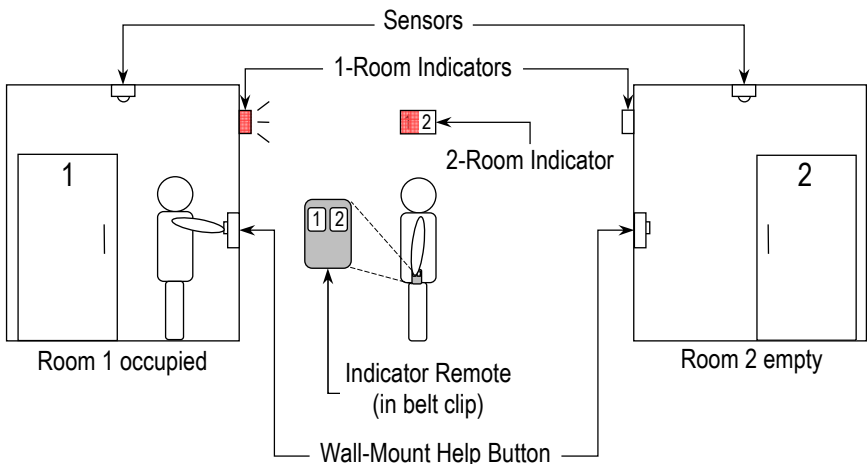

# ENFORCER Room Occupancy Monitor

## Installation Using Mounting Screws:

1. Remove the top cover and PCB. Place the bottom case on the wall where it is to be mounted, and mark the wall through the two mounting holes.
2. Screw two mounting screws (not included) into the marked locations, and slide the bottom case down onto the screws, see right.
3. Tighten the screws as needed, but take care not to overtighten and ensure the case can still be removed by sliding.
4. Replace the top cover and slide back onto mounting screws.

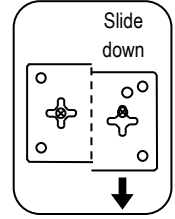

## Wiring Using Screw Terminals:

1. If needed, mark the location of the wire pass-through hole during installation and drill a hole to run wires.
2. Remove the bottom case and PCB and feed the wires through the wire pass-through holes (PCB and case) and wire as indicated below.
3. Replace the top cover and mount.

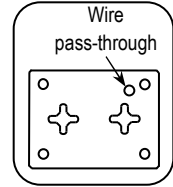

Sensor  
(RM-R100-TLQ)

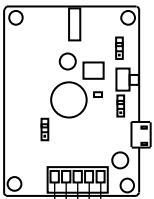

- Service input, N.O. (SIP-)
- V+ (5~12 VDC)
- Service output
- GND
- Door N.O. input (DNO+)

1-Room Indicator  
(RM-R100-RB1Q)

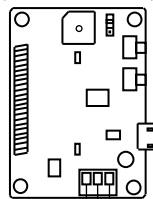

- V+ (5~12 VDC)
- GND
- Service input, N.O. (SIP-)

2-Room Indicator  
(RM-R100-R2Q)

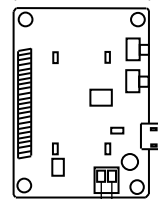

- V+ (5~12 VDC)
- GND

## Using a Magnetic Contact for Door Monitoring:

- Door monitoring should only be used for applications where the door being monitored is usually kept open.
- If an N.C. magnetic contact is being used to monitor the door then a 100kΩ resistor (not included) should be installed between the voltage and door contact inputs.

N.O. Magnetic Contact

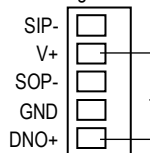

N.C. Magnetic Contact

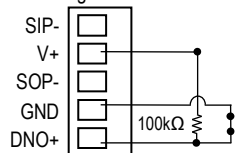

Sensor terminal block

**Specifications:**

Model		RM-R100-TLQ	RM-R100-RB1Q	RM-R100-R2Q
Description		Sensor	1-Room Indicator	2-Room Indicator
Indicators		LED	Buzzer and LED	LED
Memory capacity		N/A	15 Transmitter codes, per channel	
Current draw	Standby	2mA@12VDC	6mA@12VDC	
	Active	15mA@12VDC max.	35mA@12VDC max.	
Transistor ground rating		100mA max.	N/A	
PIR Sensor range		~16' (5m)	N/A	
Phototransistor sensitivity		≥320Lux	N/A	
Door input		NO or NC	N/A	
RF Range*		100' (30m)		
Operating frequency		433.92MHz		
Operating voltage		5VDC via micro USB or 5~12 VDC via terminal block		
Connections		Screw terminals		
Operating temperature		-4°~167° F (-20°~75° C)		
Dimensions		2 1/2" x 1 5/16" x 1 7/8" (64x24x48 mm)		
Weight		1.8-oz (50g)		

\*Actual operating range will vary greatly depending on the installation and operating environment.

**PIR Sensor Detection Angle:**

The Sensor's PIR sensor can detect movement up to ~16ft (5m). However, be sure to take into account the height and angle at which the transmitter is mounted. Refer to the diagrams below to help you decide the best height, and orientation, to mount your Room Monitor Sensor.

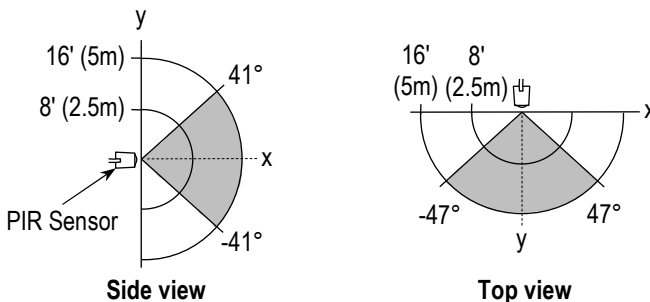







# ENFORCER Room Occupancy Monitor

## Troubleshooting:

Doesn't work	• Check Micro USB and USB adapter connection or wiring
Sensor will detect occupancy when room is empty	• If the room has a window, limit the amount of outdoor light or set the phototransistor OFF via the jumper
1-Room Indicator's buzzer keeps sounding	• Clear the memory of the service button channel in case any Sensors were accidentally paired

## Also Available from SECO-LARM®:

<b>Additional 1-Room Indicator</b>  RM-R100-RB1Q	<b>Additional 2-Room Indicator</b>  RM-R100-R2Q	<b>Additional Sensor</b>  RM-R100-TLQ
<b>Wall-Mount Help Button</b>  RM-R100-TBQ	<b>Indicator Remote</b>  RM-R100-TH2Q	<b>433.92MHz RF Receiver</b>  SK-910RB-4Q

### FCC COMPLIANCE STATEMENT

FCC ID: K4ER100TLQ

THIS DEVICE COMPLIES WITH PART 15 OF THE FCC RULES. OPERATION IS SUBJECT TO THE FOLLOWING TWO CONDITIONS: (1) THIS DEVICE MAY NOT CAUSE HARMFUL INTERFERENCE AND (2) THIS DEVICE MUST ACCEPT ANY INTERFERENCE RECEIVED, INCLUDING INTERFERENCE THAT MAY CAUSE UNDESIRABLE OPERATION.

Notice: The changes or modifications not expressly approved by the party responsible for compliance could void the user's authority to operate the equipment.

IMPORTANT NOTE: To comply with the FCC RF exposure compliance requirements, no change to the antenna or the device is permitted. Any change to the antenna or the device could result in the device exceeding the RF exposure requirements and void user's authority to operate the device.

**WARRANTY:** This SECO-LARM product is warranted against defects in material and workmanship while used in normal service for one (1) year from the date of sale to the original customer. SECO-LARM's obligation is limited to the repair or replacement of any defective part if the unit is returned, transportation prepaid, to SECO-LARM. This Warranty is void if damage is caused by or attributed to acts of God, physical or electrical misuse or abuse, neglect, repair or alteration, improper or abnormal usage, or faulty installation, or if for any other reason SECO-LARM determines that such equipment is not operating properly as a result of causes other than defects in material and workmanship. The sole obligation of SECO-LARM and the purchaser's exclusive remedy, shall be limited to the replacement or repair only, at SECO-LARM's option. In no event shall SECO-LARM be liable for any special, collateral, incidental, or consequential personal or property damage of any kind to the purchaser or anyone else.

**NOTICE:** The SECO-LARM policy is one of continual development and improvement. For that reason, SECO-LARM reserves the right to change specifications without notice. SECO-LARM is also not responsible for misprints. All trademarks are the property of SECO-LARM U.S.A., Inc. or their respective owners. Copyright © 2019 SECO-LARM U.S.A., Inc. All rights reserved.

## SECO-LARM® U.S.A., Inc.

16842 Millikan Avenue, Irvine, CA 92606  
Phone: (949) 261-2999 | (800) 662-0800

Website: [www.seco-larm.com](http://www.seco-larm.com)  
Email: [sales@seco-larm.com](mailto:sales@seco-larm.com)

 PITSWI

MI\_RM-R100-xxxQ\_190218.docx